

H&L® "Cobra Line" *Parabolic® Style Pins, Flexpins® and Steel Keepers

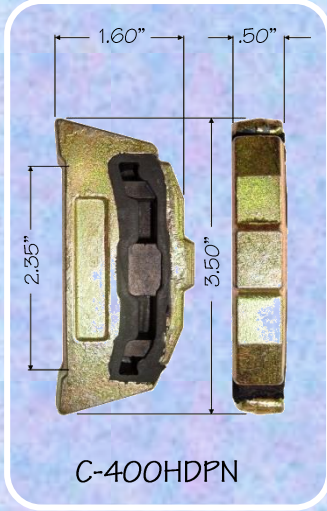
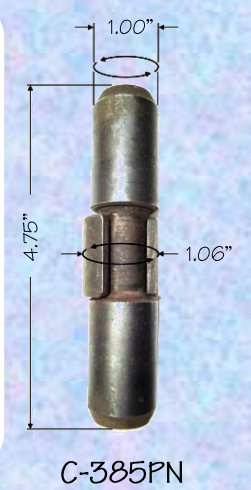
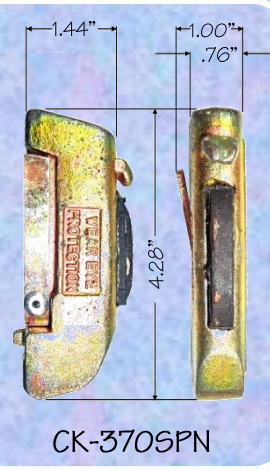
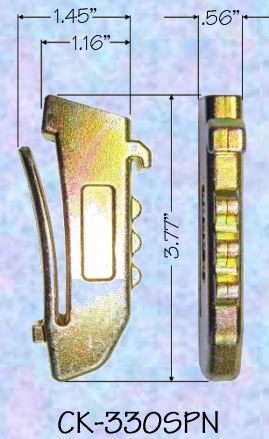
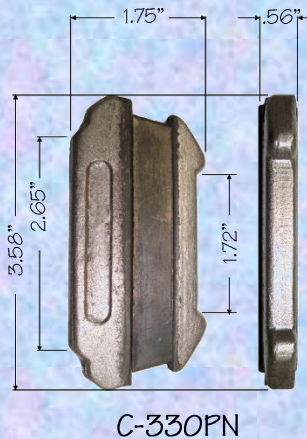
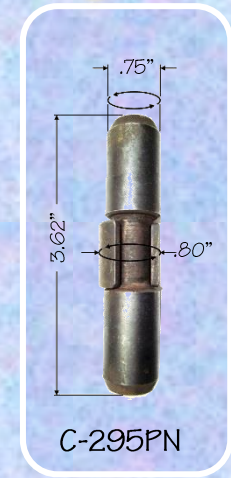
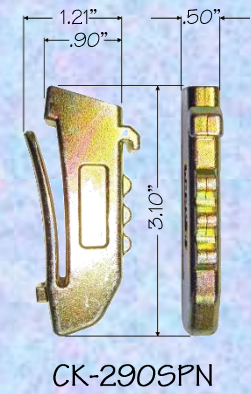
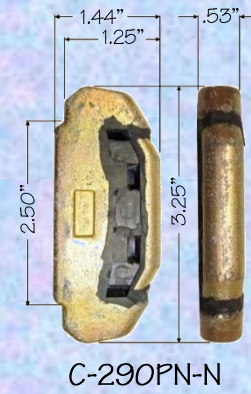
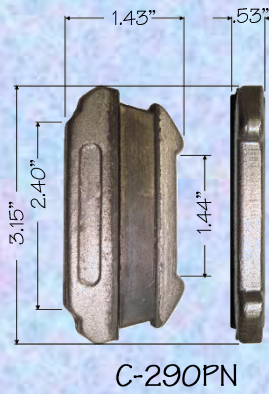
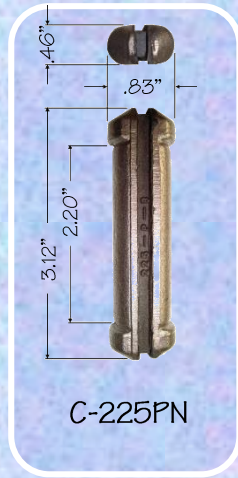
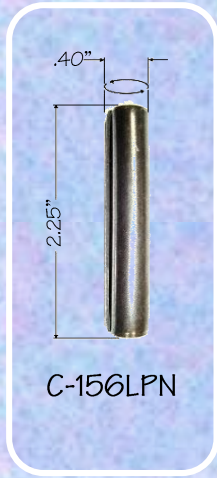

COBRA LINE PRODUCT
H&L® TOOTH COMPANY
 Factory in Tulsa, Oklahoma

"Cobra Line" Hensley® Style
 PINS, FLEXPINS AND STEEL KEEPERS

H&L Tooth Company History since 1931:
 H&L "Cobra Line" Pins, Flexpins and Steel Keepers meet or exceed OEM specification and requirements. All dimension noted are for reference purposes only, dimensions may vary from pin to pin.
 H&L number; C-156LPN, C-160PN, C-225PN, C-290PN, C-290SPN, CK-290SPN, C-295PN, C-330PN, CK-330SPN, C-370PN, CK-370PN, C-385PN, C-40HDPN, C-410PN, CK-410SPN, C-410STPN, C-450PN, CK-450SPN, C-475PN, C-500PN, C-550PN,
 Other part number references; P225, P290, K290, P295, P310, P330, K330, P370, K370, P385, P400, P410, K-410, P450, K-450, P475, P500, P550.
 H&L is an ISO CERTIFIED Company.



H&L® "Cobra Line" *Parabolic® Style Pins, Flexpins® and Steel Keepers

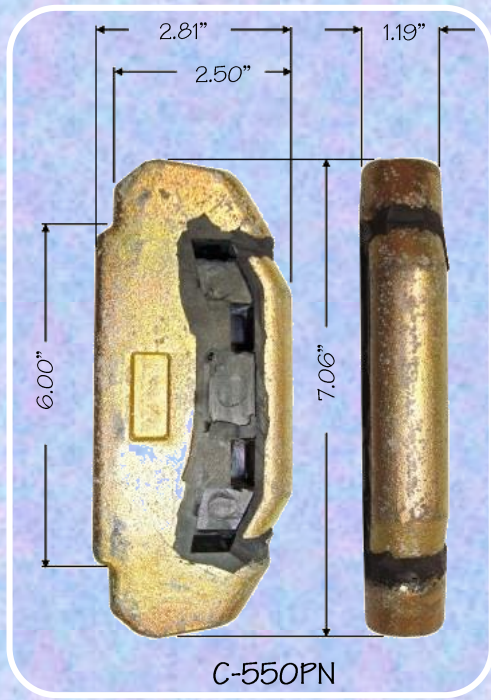
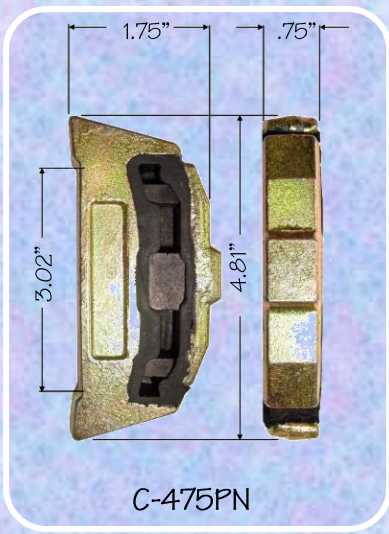
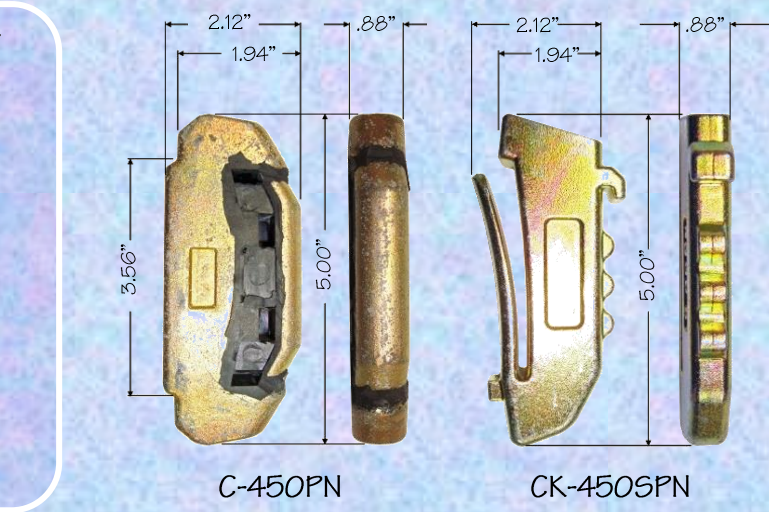
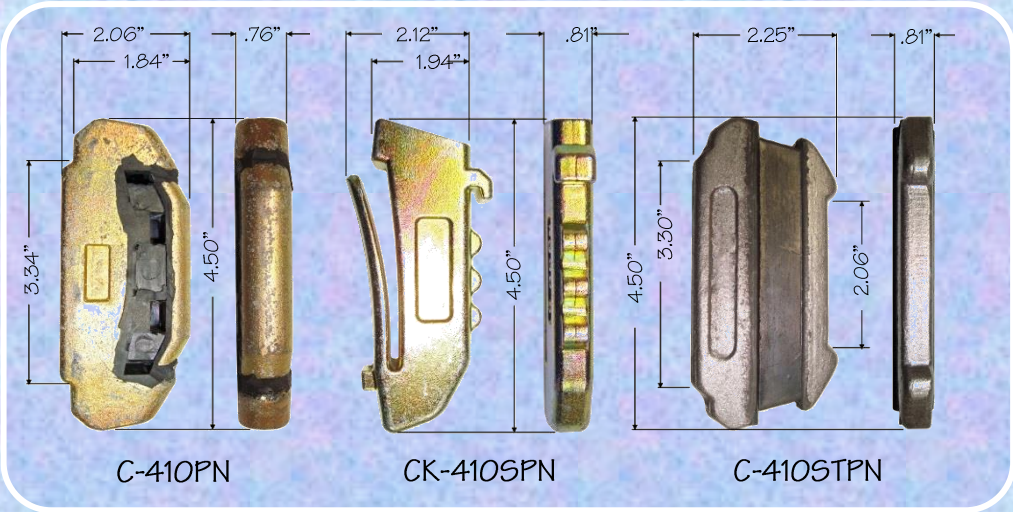

**Parabolic® is the registered trademark of the Hensley-Komatsu Company. Flexpin is the registered trademark of the H&L Tooth Company.*