

T366.2023



H&L's C-35S Teeth are produced from aircraft quality Chrom-Moly grade alloy steels to enhance tooth **DURABILITY** and long **LASTING SHARPNESS!**

© H&L Tooth Company 2023



Uses the C-35 Series Rubber Insert and Steel Pin

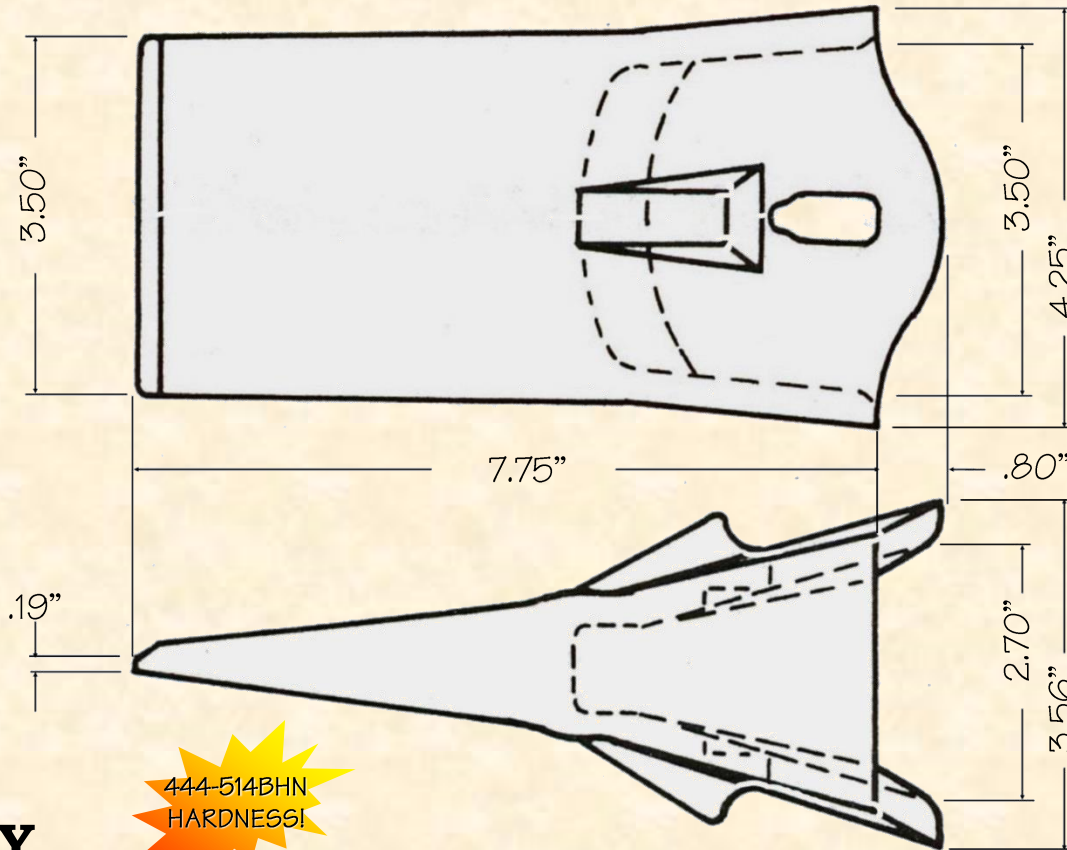

ORIGINAL PRODUCT
H&L® TOOTH COMPANY

Factory Direct from Tulsa, Oklahoma

H&L *Cobra Line* cast conical shaped Nosepiece

C-35S

Sharp Tooth
9.1#/4.13 kgs.

*H&L Tooth Company History since 1931:
This CF-35S Sharp style tooth was introduced by the Hi-Pro Forge Company in 1981 as a forging. During the 2000s H&L redesigned the CF-35S and now offers it as a cast version C-35S.*

Today, copies of the Conical "C and CF" 35S style teeth are being produced by many companies worldwide.